

42" CLASS (42.0" DIAGONAL)

42LC50C

37" CLASS (37.0" DIAGONAL)

37LC50C
37LC50CB

32" CLASS (31.5" DIAGONAL)

32LC50C
32LC50CB
32LC50CS

LCD TV

LCD Widescreen HDTV with HD-PPV Capability

preliminary



NATIVE DISPLAY RESOLUTION
1366 x 768

MPEG-2/MPEG-4 H.264
DECODING

 **green** DYNAMIC POWER SAVINGS
Up to 65% - 42", 60% - 37", 54% - 32"
power savings with feature enabled

HD VOD PPV ENCRYPTION
Integrated Pro:Idiom®

BUILT-IN TUNERS
ATSC/NTSC/QAM Clear

DYNAMIC CONTRAST RATIO
12,000:1

LG's EXCLUSIVE XD ENGINE™

SPLIT SCREEN
Using optional auto-sensing
remote jack pack (RJP)

AUTO-SENSING REMOTE JACK PACK
(RJP) COMPATIBLE

2 HDMI™ INPUTS WITH HDCP

2-YEAR LIMITED WARRANTY
parts/labor

NOTE: IP-Cast™ ready with integrated card slot using LG's IP card solution for Digital Signage applications (sold separately). Contact DSinfo@LGcommercial.com for more information. If using DIRECTV's™ Free-To-Guest, an additional card may be required.

www.LGcommercial.com

 **LG**
Life's Good

XD ENGINE

SHARPER
BRIGHTER
CLEARER

ULTRA CONTRAST
AT A BLAZINGLY FAST 370 MILLION PIXELS PER SECOND, THE PROCESSOR USES A HISTOGRAM ANALYZATION TOOL TO CLARIFY THE IMAGE DATA ACCORDING TO SIGNAL BRIGHTNESS LEVELS.

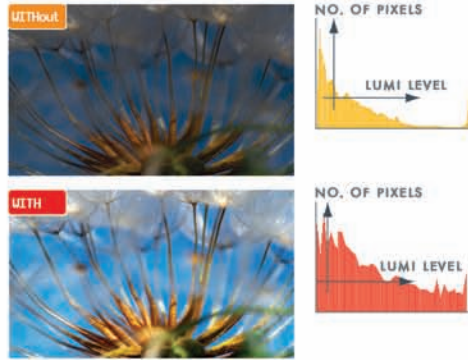

Dramatization

DYNAMIC BLACK STRETCH
THE MINIMUM BLACK LEVEL OF AN IMAGE IS AUTOMATICALLY DETECTED AND ADJUSTED ACCORDING TO BRIGHTNESS.

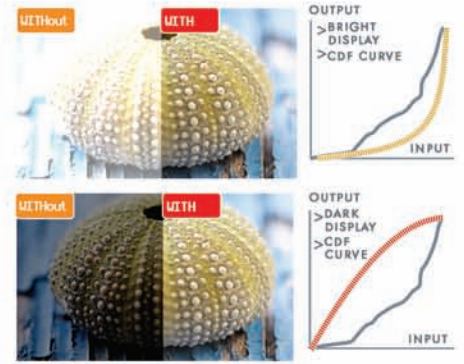

Dramatization

OPTIONS

AVAILABLE COLORS

42LC50C (high gloss black)
37LC50C (high gloss black)
32LC50C (high gloss black)



37LC50CB (matte black)
32LC50CB (matte black)



32LC50CS (silver)



FREE-TO-GUEST CARD



HCS1410
FREE-TO-GUEST CARD

The HCS1410 card can be inserted into the MPI slot on the back of the LC50 series. It is to be used for properties without a Pay-Per-View system but still want to receive Pro:Idiom™ locked free-to-guest high-definition channels.

CLONING PROGRAMMER REMOTE



LT2002
QUICKSET II "CLONE"

The LT2002 allows for custom setup and programming information to be quickly copied from a "master" LG or Zenith brand LCD, Plasma, or CRT TV (with the MPI™ input) into an unlimited number of identical models. This saves the installers hours of time duplicating the hotel TV settings, such as minimum volume, maximum volume, start up channel, channel mapping, etc.

DYNAMIC POWER SAVINGS* (test condition - component 216 gray pattern)

42LC50C

PTC VALUE	LUMINA CE (cd/m ²)	POWER CONSUMPTION (w)	POWER SAVINGS RATING
200	110	118	44%
190	110	118	44%
180	110	118	44%
170	110	118	44%
160	110	118	44%
150	110	118	44%
140	110	118	44%
130	50	107	49%
120	45	94	55%
110	33	83	61%
101	16	74	65%

37LC50C

PTC VALUE	LUMINA CE (cd/m ²)	POWER CONSUMPTION (w)	POWER SAVINGS RATING
200	121	88	46%
190	121	88	46%
180	121	88	46%
170	121	88	46%
160	121	88	46%
150	121	88	46%
140	121	85	48%
130	118	82	50%
120	102	78	52%
110	86	72	56%
101	75	66	60%

32LC50C

PTC VALUE	LUMINA CE (cd/m ²)	POWER CONSUMPTION (w)	POWER SAVINGS RATING
200	92	75	42%
190	92	75	42%
180	92	75	42%
170	92	75	42%
160	92	75	42%
150	92	75	42%
140	92	73	44%
130	85	70	46%
120	74	66	49%
110	62	62	52%
101	51	60	54%

* Selectable through Installer Menu (Back Lighting Setting)

CLEAR SCREEN

USING THE NOISE FILTER INSIDE THE XD ENGINE[®] CHIP, THE IMAGE IS ANALYZED FOR TEMPORAL AND SPATIAL INFORMATION TO REDUCE MPEG NOISE.

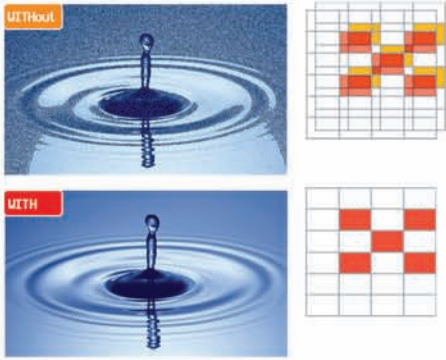

Dramatization

ADVANCED VIVID COLOR

COLORS THAT ARE SENSITIVE TO THE HUMAN EYE ARE OPTIMIZED TO THE NEAREST TRUE COLOR BY THE SELECTIVE COLOR CONTROL.

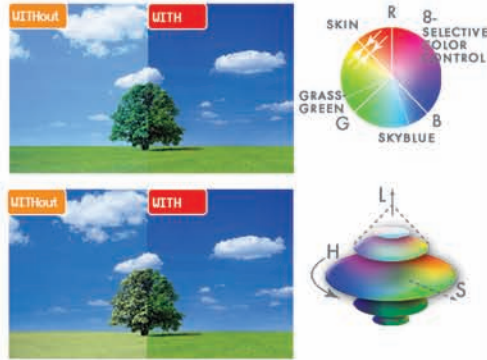

Dramatization

INTELLIGENT EDGE CONTROL

EDGE LINES ARE EMPHASIZED BY IMPROVING THE TRANSITION FROM THE BACKGROUND TO THE MAIN OBJECT.

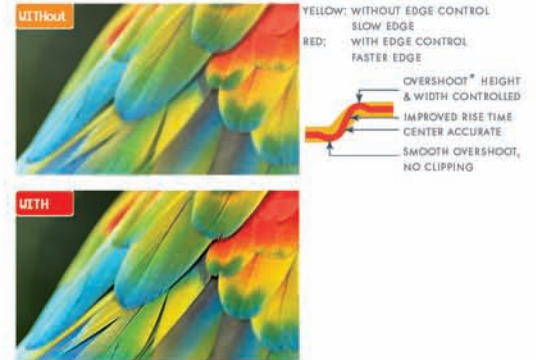

Dramatization

Pro:Idiom[®]

DIGITAL RIGHTS MANAGEMENT SYSTEM

The Pro:Idiom system's high-quality security unlocks access to premium content availability to help assure rapid, broad deployment of HDTV and other high value digital content. Pro:Idiom[™] has been designed specifically for industries that use premium HDTV content from cable, satellite or video on demand (VOD) services and as such, could result in lower costs, and reduced maintenance. This system is one of the leading DRM systems embraced by content providers for both of these key programming sources. By using this embedded approach, security is provided and helps eliminate the possibility of customers tampering with or removing needed components.

MPEG-4 TECHNOLOGY

(Moving Picture Experts Group) MPEG-4 decodes and delivers high-definition programming it receives via satellite. The advanced coding system is compatible with national and local HD channels, along with digital channels currently launched by DIRECTV. LG built this technology into its LC50 series TVs to delivery pure HD without the need for an external box*.

* Certain functions, such as Pay-Per-View, may require a set-top box.

DIMENSIONS

42LC50C

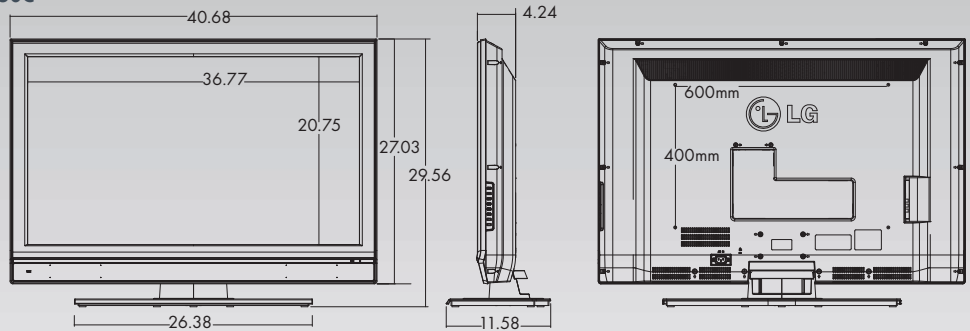

37LC50C/CB

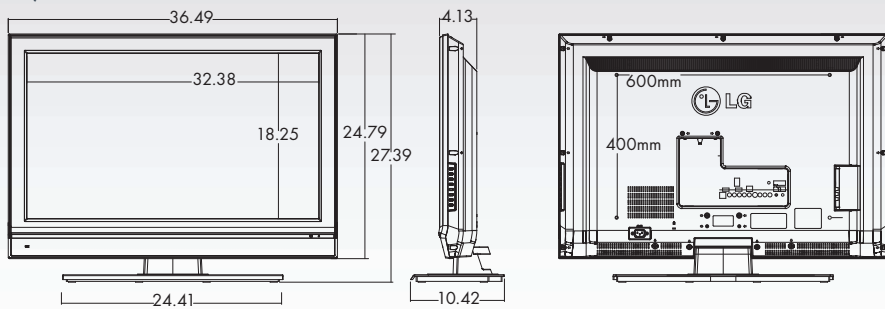

32LC50C/CB/CS

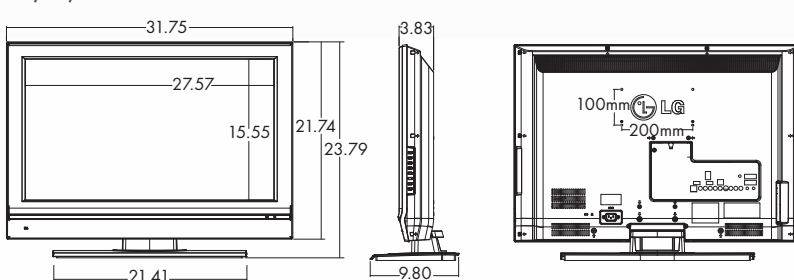

REAR JACK PANEL

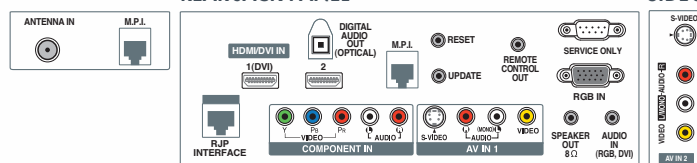

SIDE JACK PANEL



42LC50C	42" CLASS (42.0" DIAGONAL)
37LC50C	37" CLASS (37.0" DIAGONAL)
37LC50CB	
32LC50C	32" CLASS (31.5" DIAGONAL)
32LC50CB	
32LC50CS	

SPECIFICATIONS

PANEL	
LCD Panel Type	42" (42LC50C) 37" (37LC50C/CB) 32" (32LC50C/CB/CS)
Display Area	42.0" diagonal (42LC50C) 37.0" diagonal (37LC50C/CB) 31.5" diagonal (32LC50C/CB/CS)
Dynamic Contrast Ratio	12,000:1
Contrast Ratio	1600:1 (42", 37") 1500:1 (32")
Native Display Resolution	1366 x 768
Maximum Computer Resolution (RGB)	XGA (1024x768)
Brightness	500 cd/m ²
Lamp Life	60,000 hours (approx.)
Viewing Angle (HxV)	178° x 178°
Super IPS	Yes (42", 37") No (32")
Response Time	8ms (max)
VIDEO	
ATSC/NTSC/QAM Clear Tuners	Built-in
Program Guide Type	PSIP
Comb Filter	3D Digital
Color Temperature	Cool, Normal, Warm
3:2 Pull Down Cinema Correction	Yes
Aspect Ratio Adjustment	7 Modes
EZ Picture Selection Mode	5 Modes
XD Engine™	Yes
Blue/Black Stretcher	Yes
All Format Converter	1080i/720p/480p/480i~768p
Enhanced Video	Yes
DLTI (Digital Luminance Transient Improver)	Yes
DCTI (Digital Color Transient Improver)	Yes
Decoder Formats	MPEG-2/MPEG-4 H.264
AUDIO	
Audio Power	20W (10Wx2)
Speaker System Details	1 Way 2 Speaker
3D EchoSound System	Yes
Dolby Digital Decoder	Yes
Bass/Treble/Balance	Yes
EZ SoundRite (Auto Volume Limiter)	Yes
EZ Sound/Sound Selection Mode	6 Modes
Mute	Yes
Mono/Stereo/SAP	Yes
INPUTS/OUTPUTS	
RF In	1 (ATSC/NTSC)
HDMI™	Inputs 2
RGB In (PC/DTV Input)	1 (XGA Max. Resolution)
S-Video In	1 Rear/1 Side
Composite Video & Audio L/R In	1 Rear/1 Side
Digital Audio Out (Optical)	1
Audio In (RGB/DVI with Adapter)	1
Component HD/DVD & Audio L/R In	1
Audio In (Phone Jack)	1
Speaker Out	1 (1 Watt, Mono)
RS-232C Input (Service Only)	1
Remote Control Out (IR)	1
RJ45 for RJP Interface	1
MPI™ (RJ11) Slot Interface	1

REQUIRED LISTINGS

UL, c-UL, NOM	Yes
---------------	-----

SPECIAL FEATURES

Integrated Pro:Idiom®	Yes
Split Screen	Yes (using optional auto-sensing jack pack)
Channel Labeling	Yes
TV Link Protocol	Yes
RJP Plug&Play Support	Yes
Discrete IR Codes	Yes
Trilingual Menus	English/Spanish/French
Sleep Timer, On/Off Timer	Yes
Flashback (Previous Channel)	Yes
Parental Control w/V-Chip	Yes
EZ Menus (High Performance Interface)	Yes
EZ Scan (Auto Channel Programming)	Yes
Closed Caption	Yes
Remote, Universal	Yes

CABINET

Dimensions with Stand (W×H×D)	40.68"×29.56"×11.58" (42") 36.49"×27.39"×10.42" (37") 31.75"×23.79"×9.8" (32")
without Stand (W×H×D)	40.68"×27.03"×4.24" (42") 36.49"×24.79"×4.13" (37") 31.75"×21.74"×3.83" (32")
Packaging (W×H×D)	44.06"×33.78"×14.72" (42") 39.33"×34.53"×10.39" (37") 40.98"×25.12"×9.1" (32")
Weight with Stand	61.3 lbs (42") 47.2 lbs (37") 32.9 lbs (32")
Weight without Stand	47.2 lbs (42") 36.8 lbs (37") 26.9 (32")
Weight with Packaging	71.9 lbs (42") 55.1 lbs (37") 40.8 lbs (32")
Cabinet Style	Table Top
Security Screws	Yes
Table Stand Included	±20° (42") ±90° (37", 32")
Power Cord Length	9 ft.
Color	Gloss Black (42LC50C, 37LC50C, 32LC50C) Matte Black (37LC50CB, 32LC50CB) Silver (37LC50CS)
VESA Standard Mount Interface	600mm x 400mm (42", 37") 200mm x 100mm (32")

UPC

42LC50C	7 19192 17423 8
37LC50C	7 19192 17421 4
37LC50CB	7 19192 17422 1
32LC50C	7 19192 17416 0
32LC50CB	7 19192 17417 7
32LC50CS	7 19192 17418 4

POWER

Power Consumption (typ.) w/o Dynamic	TBD
Power Savings	TBD
Dynamic Power Savings*	Yes (42"-65%, 37"-60%, 32"-54%)

SERVICE/LIMITED WARRANTY

Limited Warranty (Parts/Labor)	2 Years
--------------------------------	---------

* When Dynamic Power Savings feature is enabled, these power savings could be attained.

www.LGcommercial.com



LG Electronics U.S.A., Inc.
Commercial Products Division
2000 Millbrook Drive,
Lincolnshire, IL 60069

Customer Service: 888-865.3026

Contact your LG Regional Sales Representative:
Hospitality: 800.228.1236
B2B: 800.897.8788
Channel Markets: 800.897.8871

SPEC_42-37-32LC50 LG040810_v



All screen images are simulated. Dimensions and weights are approximate. Design, features and specifications subject to change without notice.

© Copyright 2008 LG Electronics USA, Inc. All Rights Reserved. "LG Life's Good" is a registered trademark of LG Corp. XD Engine is a registered trademark of LG Electronics USA, Inc. Pro:Idiom and MPI are trademarks of Zenith Electronics Corp.

VESA is a trademark of Video Electronics Standards Association. All other product and brand names are trademarks or registered trademarks of their respective companies.

Printed in the USA. July 2008